

ZUMMI

0+
MONTHS

15
KG
MAXIMUM
WEIGHT

Completo Portacot

Instruction Manual

IMPORTANT

BEFORE ASSEMBLING THIS COT READ AND UNDERSTAND THE INSTRUCTIONS.

Do not use mattress other than the one supplied by the manufacturer. Incorrect mattress can cause death.

Use only accessories as recommended by the manufacturer. Ensure the top rails and base are fully locked. Stop using this cot if any part of the cot is broken, torn or missing.

KEEP THESE INSTRUCTIONS IN A SAFE PLACE FOR FUTURE REFERENCE.

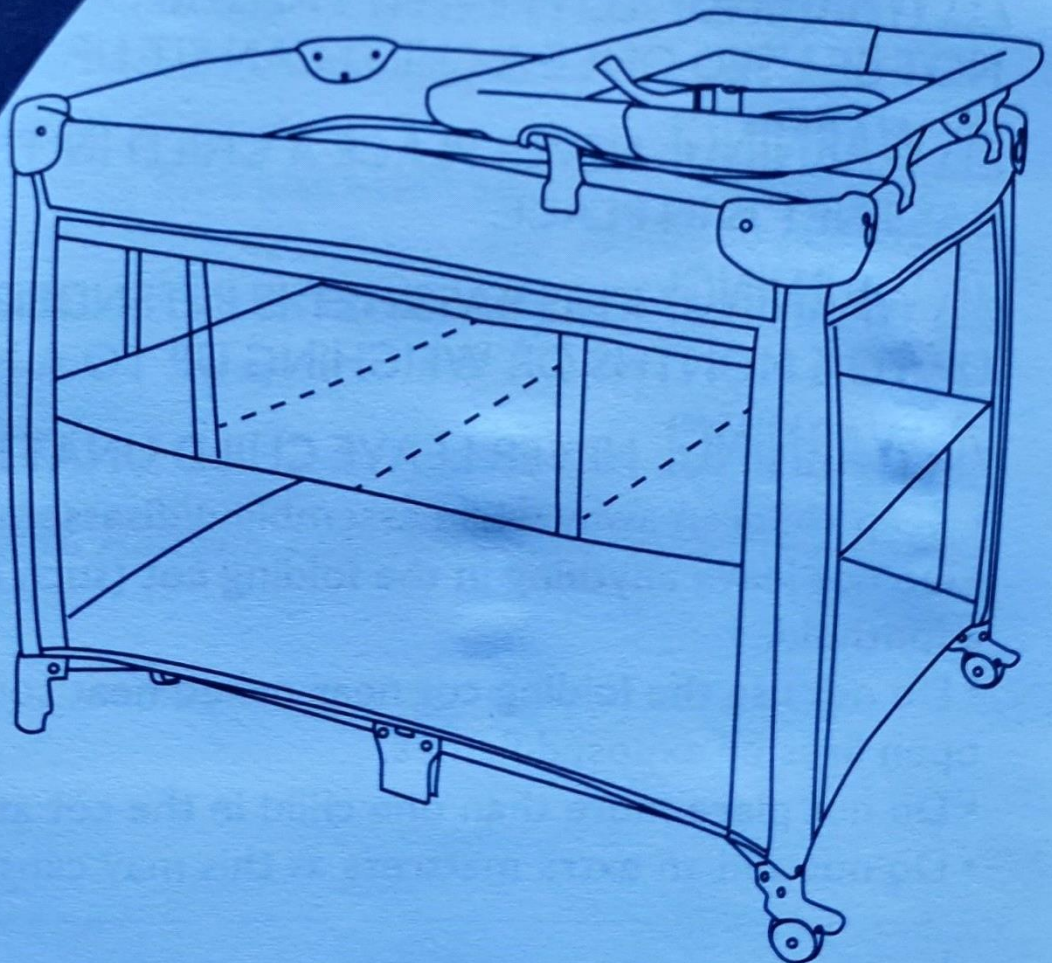



WARNINGS:

RETAIN FOR FUTURE REFERENCE.

READ ALL INSTRUCTIONS CAREFULLY BEFORE ASSEMBLY AND USE OF THIS COT.

ALWAYS FOLLOW THE INSTRUCTIONS. THE CORRECT USE AND MAINTENANCE OF THIS PRODUCT IS ESSENTIAL.

 **WARNING!** USE ONLY THE MATTRESS SUPPLIED BY THE MANUFACTURER, INCORRECT MATTRESSES CAN CAUSE DEATH.

 **WARNING!** USE ONLY ACCESSORIES AS RECOMMENDED BY THE SUPPLIER.

 **WARNING!** ENSURE THE TOP RAILS AND BASE ARE FULLY LOCKED.

 **WARNING!** DO NOT USE THIS COT IF ANY PART OF THE COT IS BROKEN, TORN OR MISSING.

 **WARNING!** THIS BASSINET SHOULD BE REMOVED BEFORE THE CHILD CAN SIT UP.

 **WARNING!** TO PREVENT FALLS REMOVE THE BASSINET MUST NOT BE USED ONCE A CHILD CAN SIT UP.

 **WARNING!** NEVER PLACE A CHILD IN THE COT WHEN THIS BASSINET IS IN PLACE.

 **WARNING!** THIS BASSINET IS INTENDED FOR ONE CHILD UP TO 6 MONTHS OR WEIGHING UP TO A MAXIMUM OF 9KG.

 **WARNING!** NEVER LEAVE CHILD UNATTENDED.

- Keep children away while assembling/disassembling the cot.
- Do not leave anything in the folding cot (such as toys) that provide a foothold.
- Do not use the folding cot near naked heat sources, bar heaters, open fires or exposed flames.
- Do not place more than one child in the cot at the same time.
- Do not add an extra mattress as this may cause suffocation.

WARNINGS:

- Do not use this cot with a child who can climb out, weighs more than 15kg, or is taller than 890mm.
- Keep the folding cot clear of trailing cables and hanging cords.
- Keep medication and small items that a child could choke on, away from the cot.
- Check that the assembly of the cot is correct and safe.
- Check that all locking devices are fully engaged.
- Folding cots with padded rims should not be used if the covering material has been bitten through.
- There is potential for fingers or parts of the body to be injured when the product is being folded or unfolded, and that due care should be exercised.
- Take care when unpacking and during assembly.
- Dispose of all packing materials carefully after assembly.
- Regularly check that all fittings remain tight. Tighten if required.
- Inspect the product before assembly and periodically during use. Never use this product if there are any loose or missing fasteners, joints or broken parts.
- To reduce the risk of Sudden Infant Death Syndrome (SIDS), paediatricians recommend healthy infants be placed on their backs to sleep, unless advised by your physician.
- Be aware of the risk of open fires and other sources of strong heat, such as electric bar fires, gas fires, etc. in the near vicinity of the product.
- Any additional or replacement parts should only be obtained from the manufacturer or distributor.
- Never substitute parts.

This product complies with AS/NZS 2195:2010 + A1:2013 + A2:2015.

Travel Cot Parts List:

A Cot x 1



B Mattress x 1

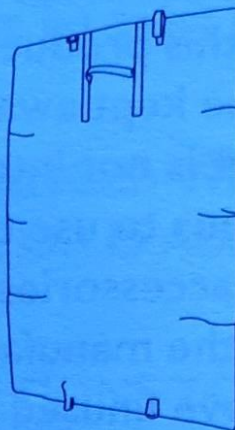

C Bassinet x 1

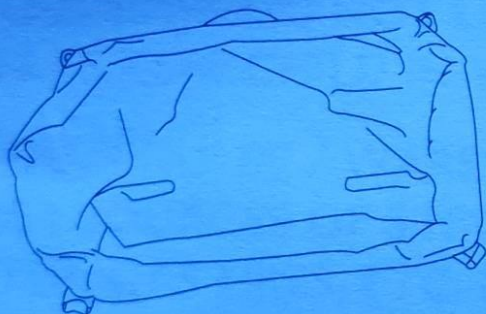

D Bassinet compression tubes x 2



E Bassinet support tubes x 2



F Bag x 1



Change Table Parts List:

G Change table x 1



H Change table bars with clips x 2

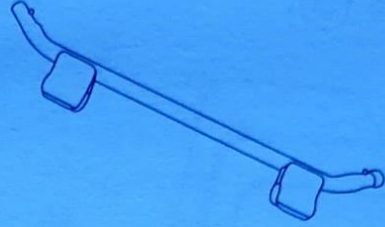

I Change table long bars x 2



To Unfold the Travel Cot

1. Unpack all contents and check that all parts are present before starting assembly. Please refer to the parts list.

Unzip the storage/ travel bag (F) and remove the travel cot (A) and mattress (B).

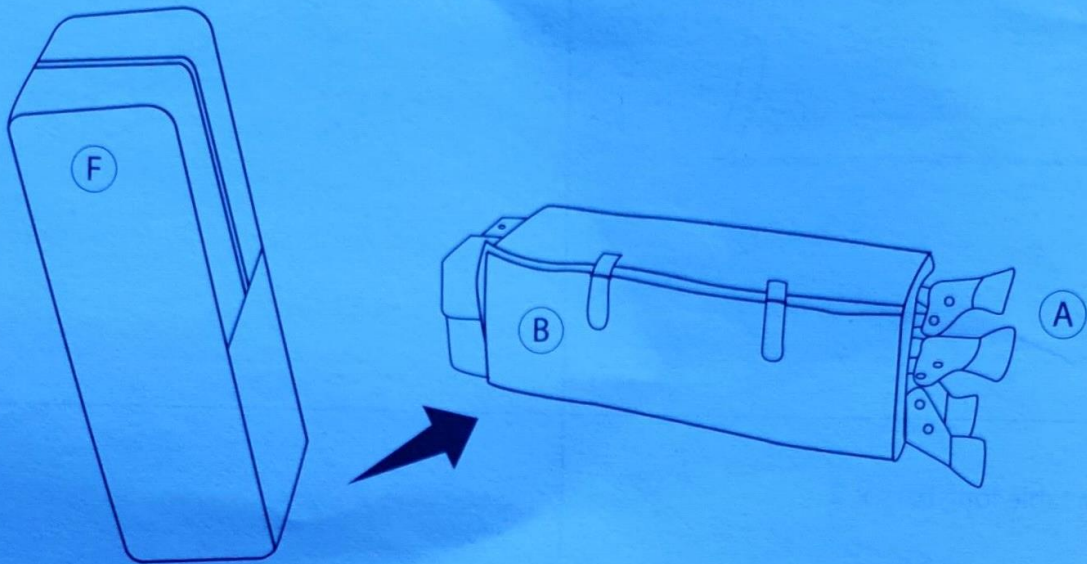

2. Place the travel cot in a vertical position. Open the velcro webbing fasteners to remove the mattress.

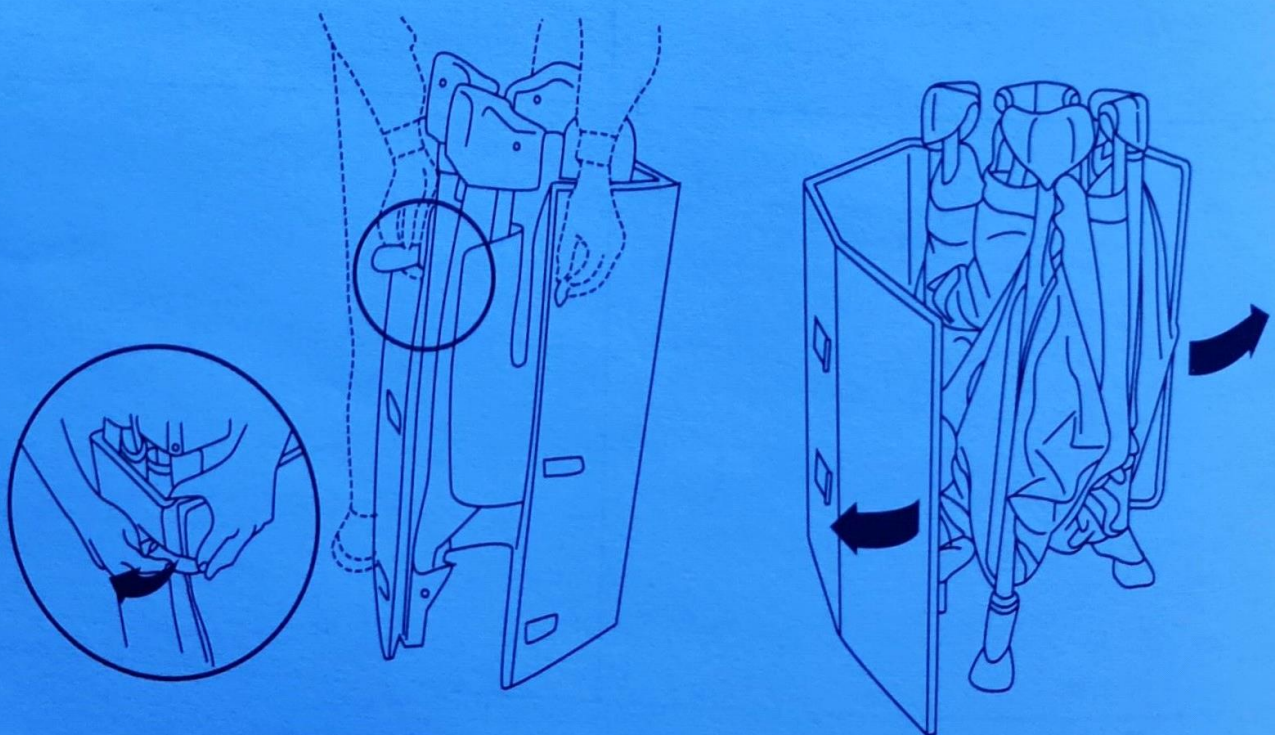

To Unfold the Travel Cot

3. With the travel cot feet on the floor pull them apart so that they are approximately 60cm/ 24" apart. Lift the smaller sides upwards until they lock into position. Repeat for the longer side rails.

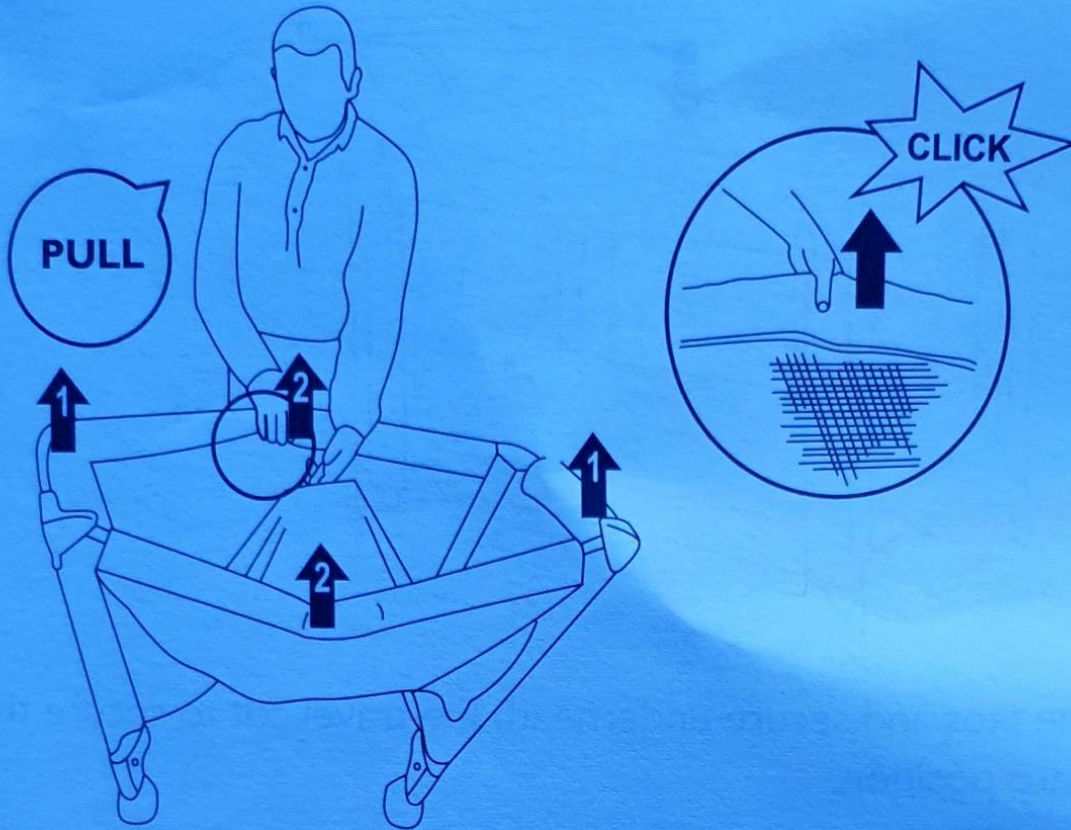

4. Push the bottom center until it is completely flat and stable.

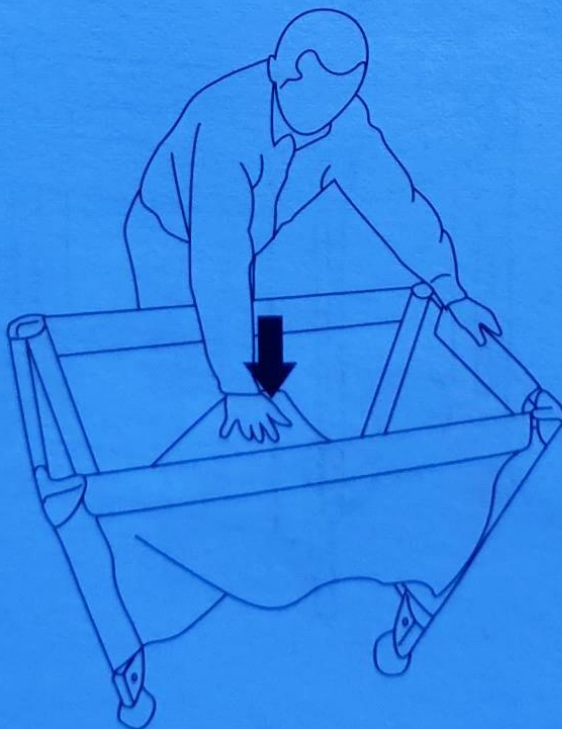

To Unfold the Travel Cot

5. Place the mattress (B) in the travel cot with the padded side up. Insert the four velcro tabs through the slots in the bottom of the travel cot.

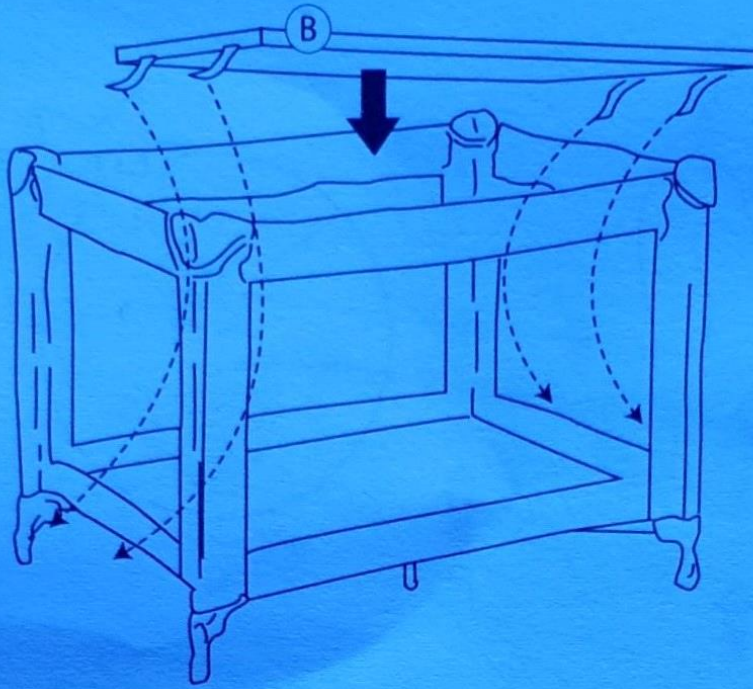

6. Fold back the tabs and secure underneath the travel cot to secure the padded base into position.

 **WARNING:** ENSURE ALL LOCKING MECHANISMS ARE ENGAGED BEFORE USE.

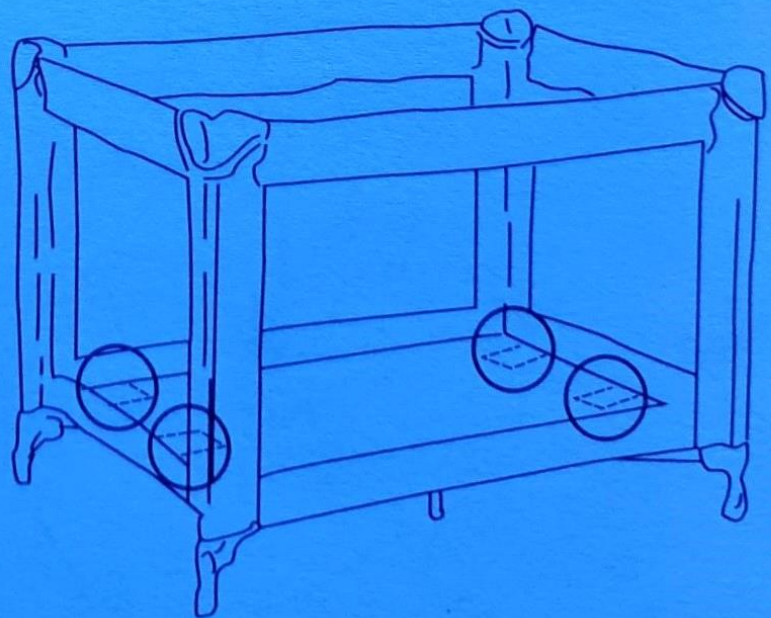
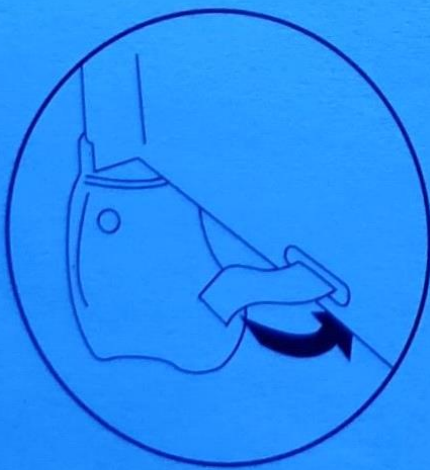

To Fold the Travel Cot

1. Undo the four velcro tabs from underneath the travel cot.

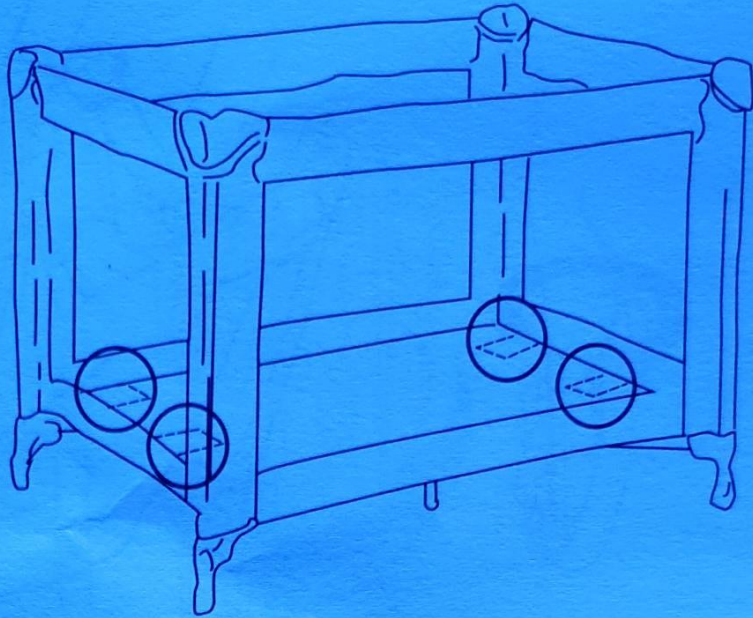
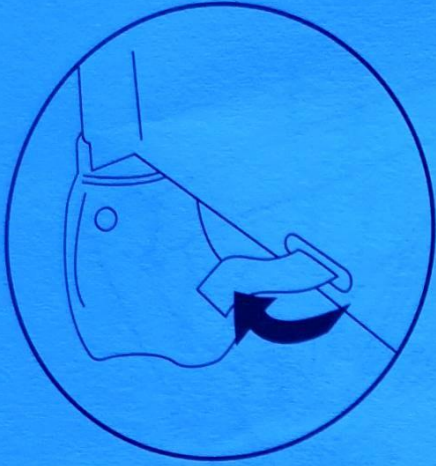

2. Remove the velcro tabs from the base of the travel cot and remove the padded base.

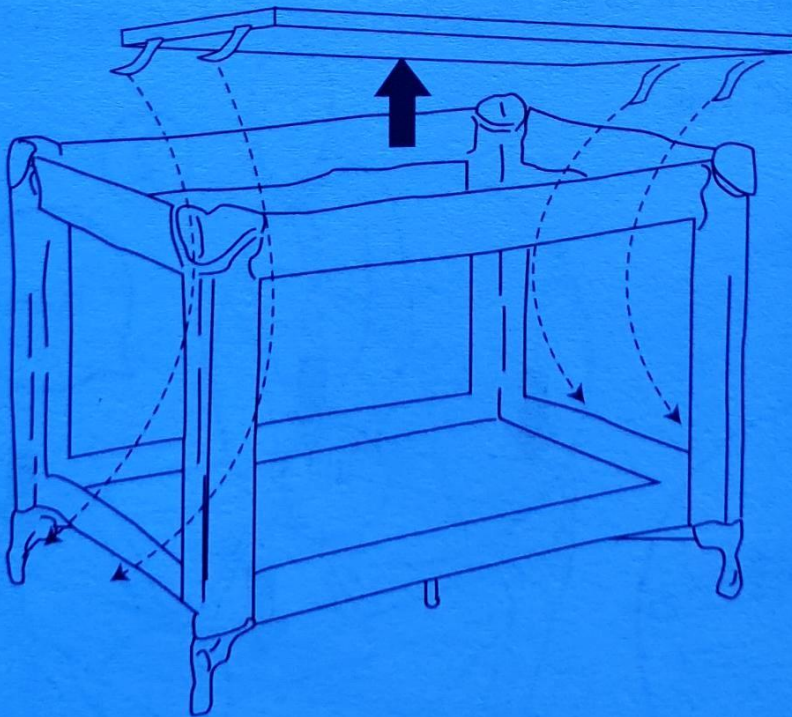

To Fold the Travel Cot

3. Grab and twist the lever anti-clockwise to release the folding mechanism. Pull lever up to it's highest point.

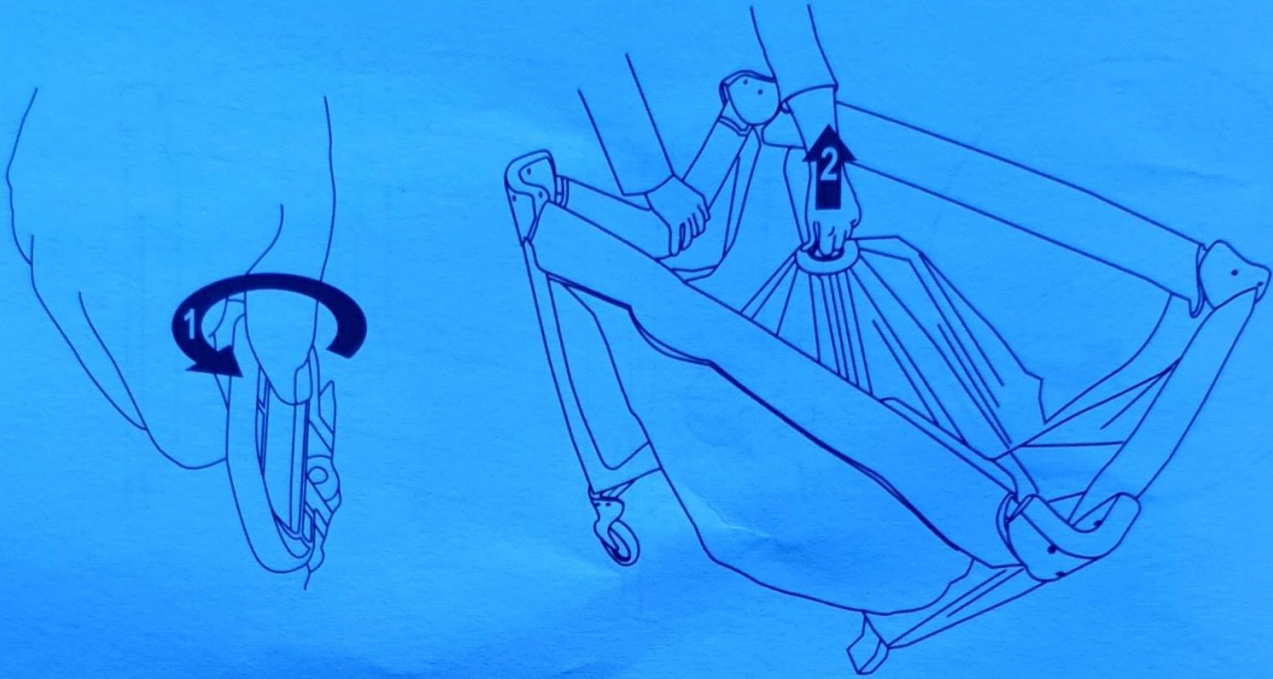

4. Locate the button at the center under each side rail. Press the button to release the side rail lock and simultaneously lower the side rail.

⚠ WARNING: IF THE TOP RAILS DO NOT RELEASE, ENSURE THAT THE BASE IS RAISED FULLY AND LIFT THE RAILS SLIGHTLY BEFORE PRESSING THE RELEASE BUTTON.

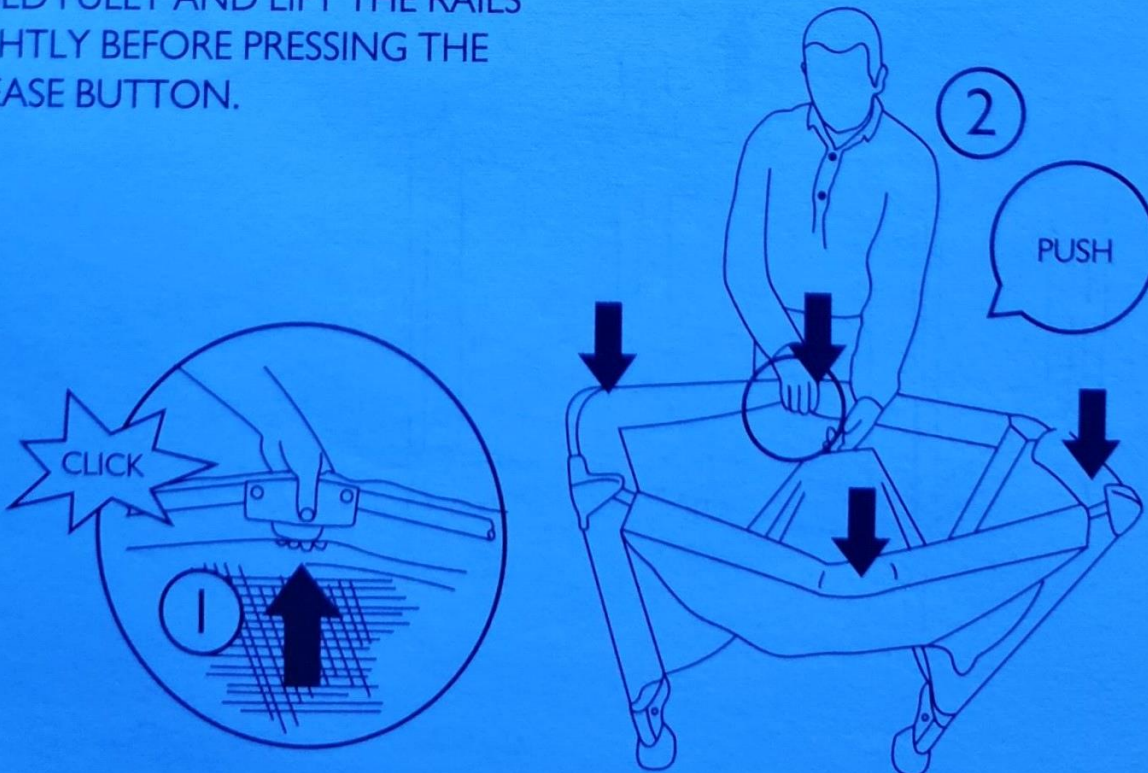

To Fold the Travel Cot

5. Push all the feet together so that the upper part of the travel cot is in the closed position. Wrap the padded base around the travel cot with the padded section facing inside.

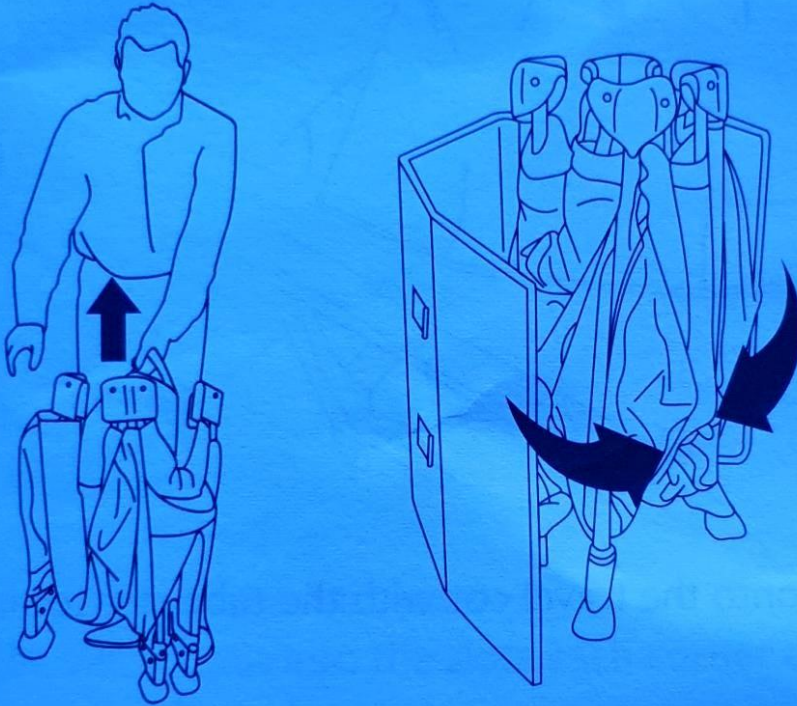

6. Fasten the velcro webbing fasteners and secure. Place travel cot back into the bag for storage or transportation.

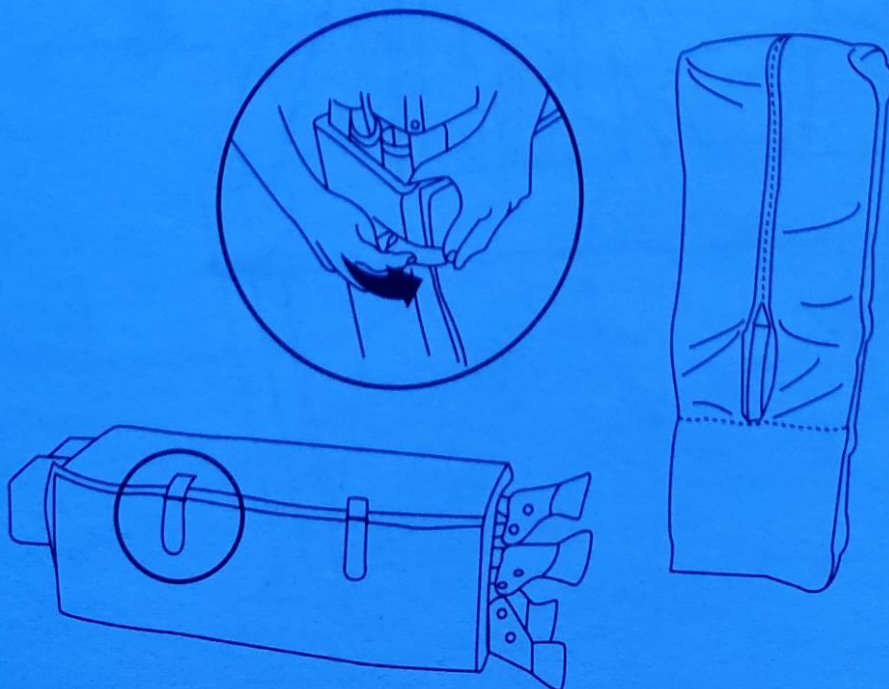

Bassinet

1. Remove the mattress from the bottom of the travel cot to use with the bassinet.

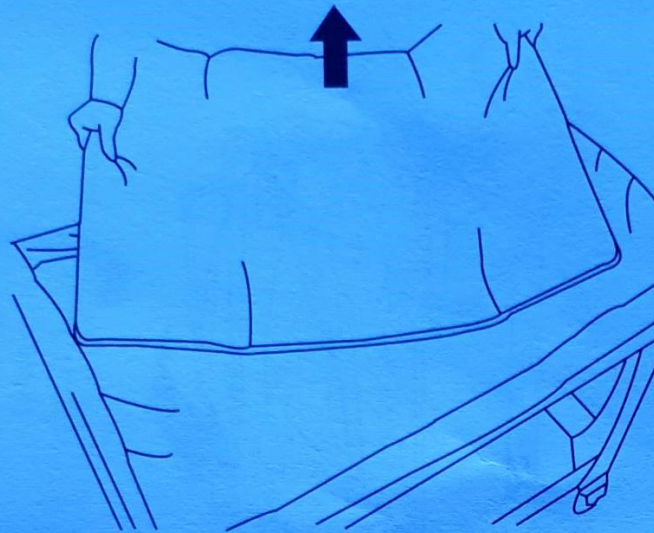

2. Zip the bassinet (C) onto the travel cot with the tube sleeves facing up.

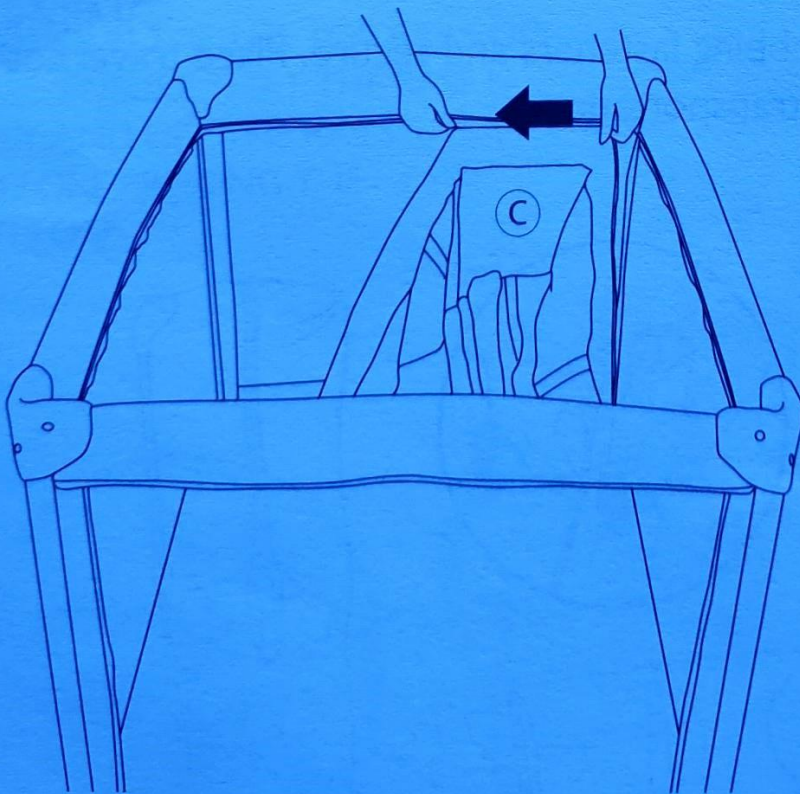

Bassinet

3. Insert the compression (D) and support (E) tubes into the sleeves until they are locked into place.
Repeat step for the rest of the metal tubes.

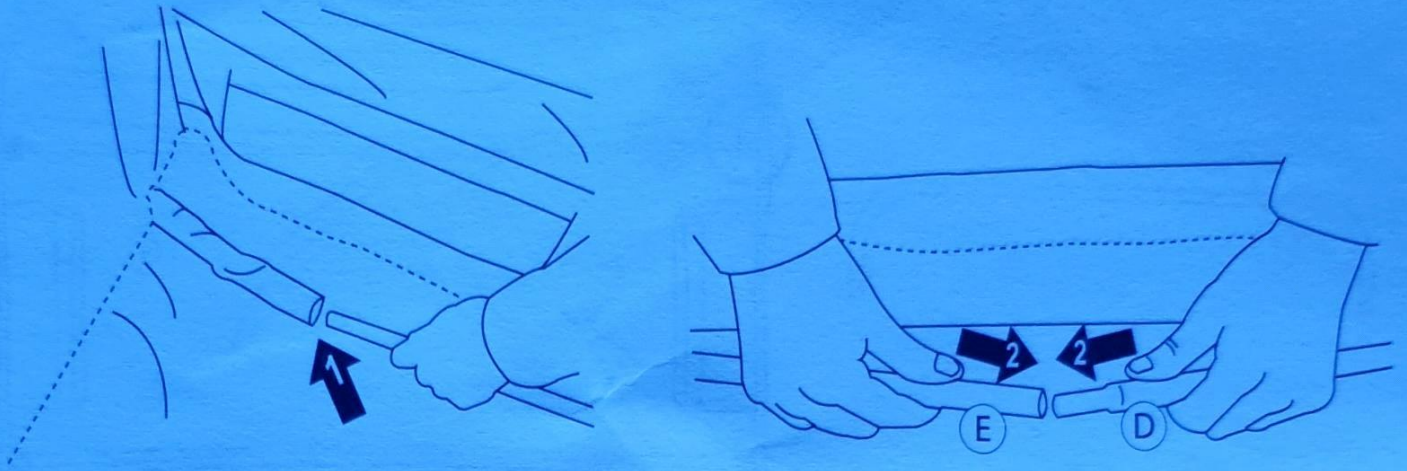

4. Place the padded base into bassinet.
5. Insert the velcro tabs into the slots each corner of the bassinet, fold back the tabs and fix underneath to secure the padded base into position.

⚠ WARNING: ENSURE ALL LOCKING MECHANISMS ARE ENGAGED BEFORE USE.

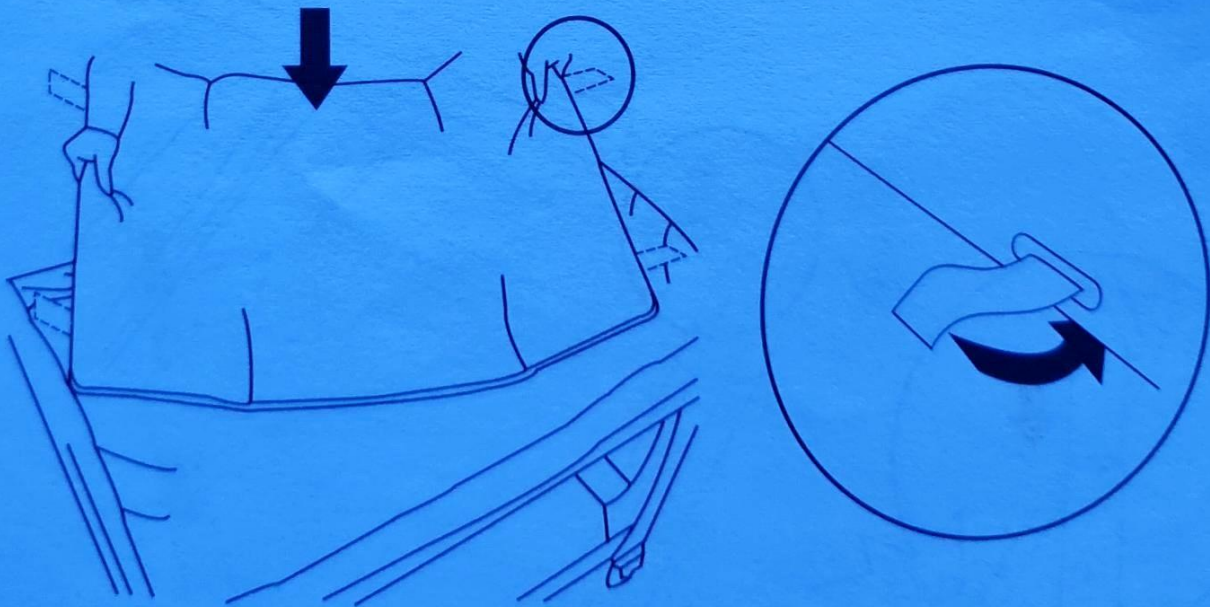

Change Table

1. Unfold the change table (G) and tidy the surface. Turn the change table over. Insert long bars (I) into the fabric pockets. Remove the rubber caps from the ends of the tubes.

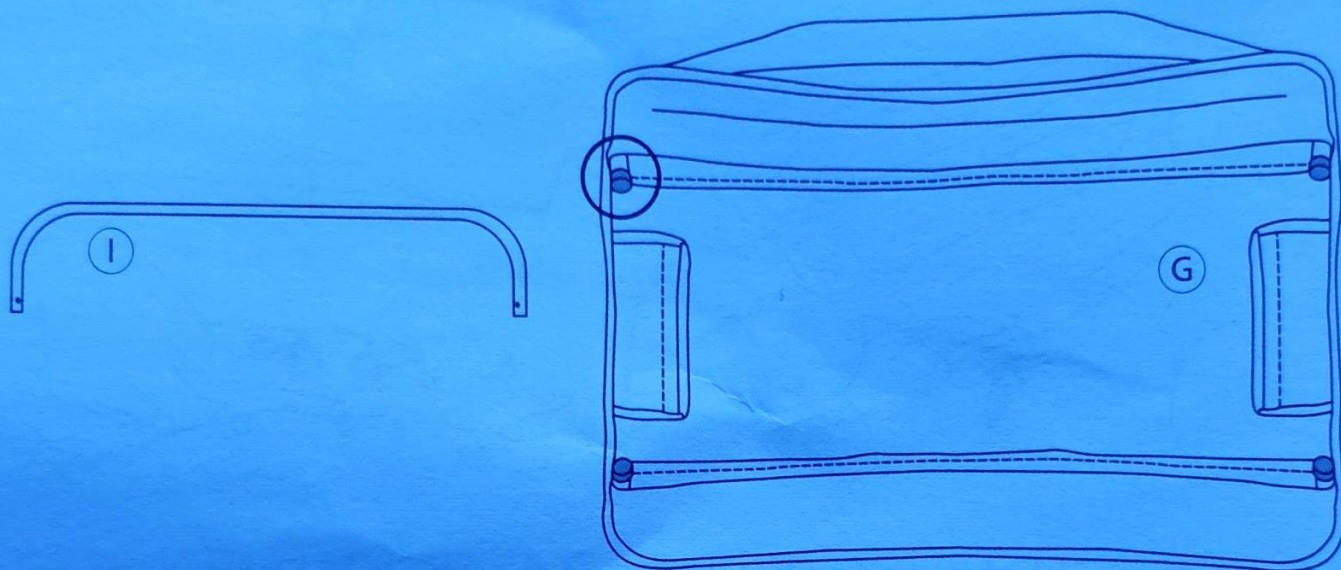

2. Remove the rubber caps from the bars with clips (H). Connect the ends of the tubes to the tubes within the change table. The spring pins will “click” into place once secure. Repeat for both sides.

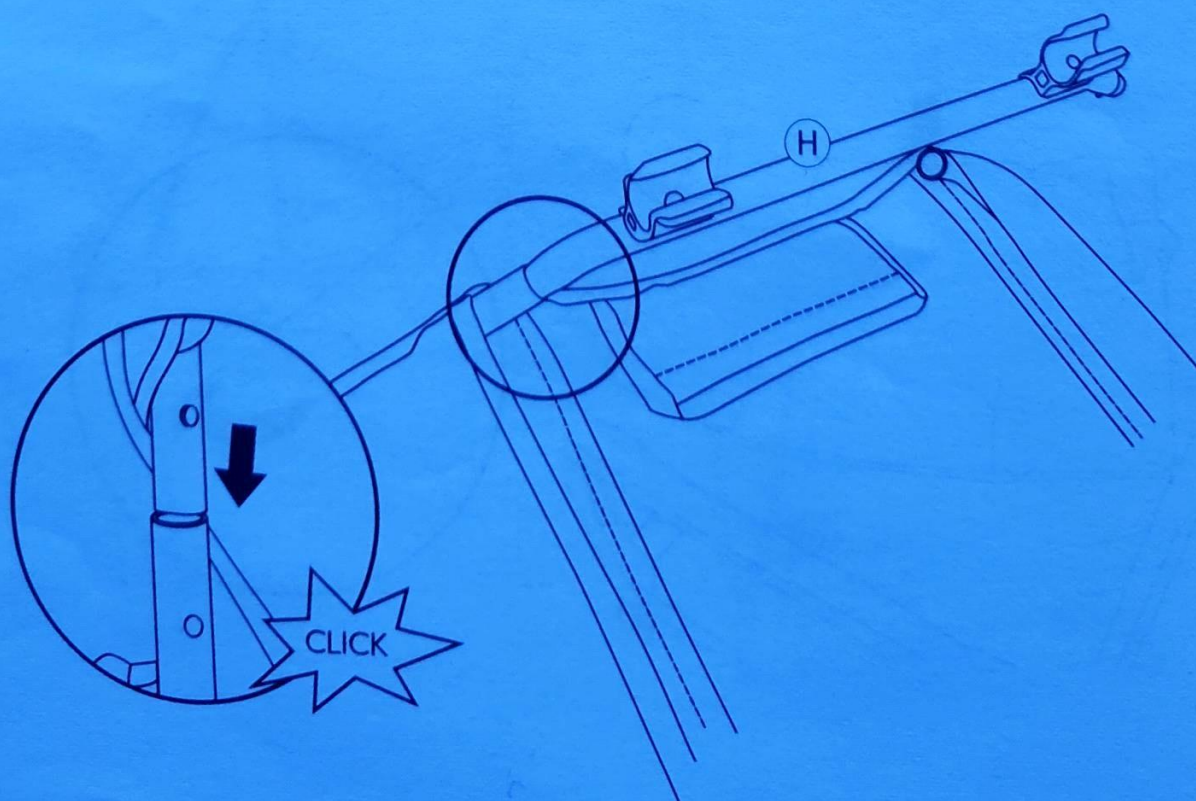

Change Table

3. Fold the flap over the assembled bars with clips and secure with velcro. Repeat for both sides.

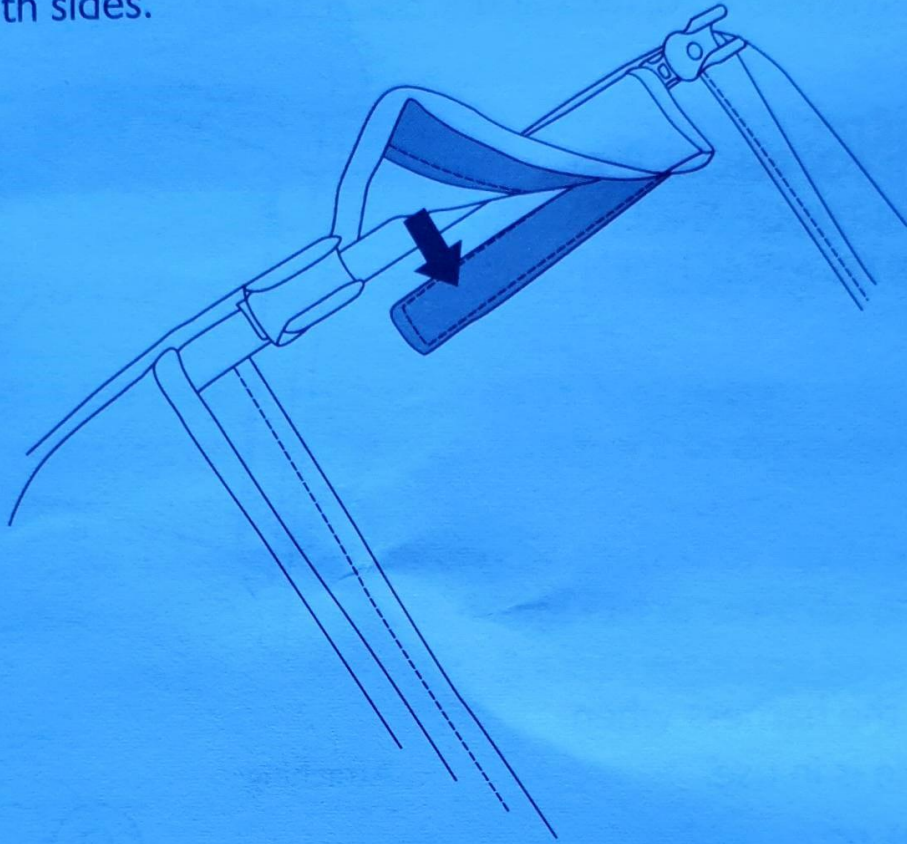

4. Attach the change table to the travel cot.

NOTE. Always make sure the 4 plastic clips are securely fastened to the change table and the travel cot when installed.

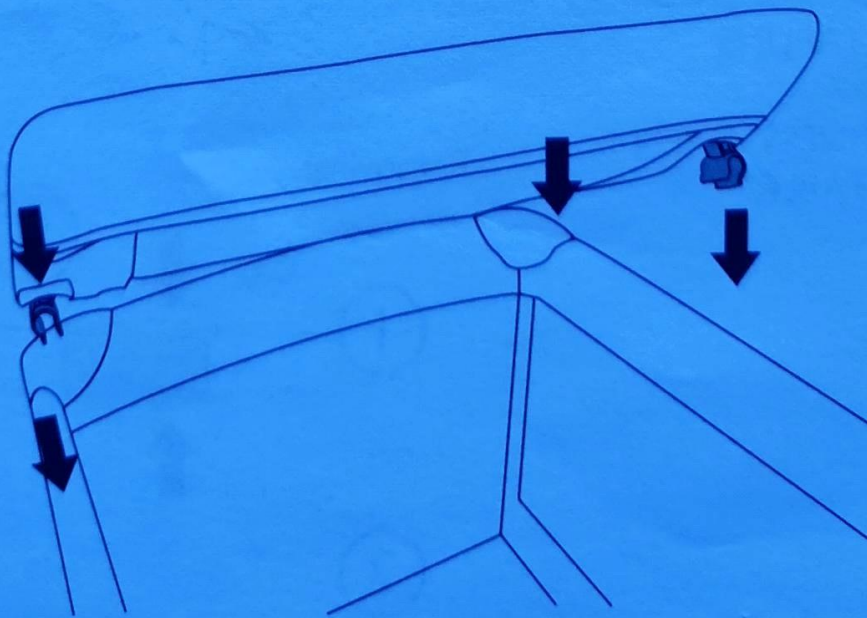

Change Table

5. Pull the change table excess fabric down over the travel cot corners and fasten the zip.

⚠ WARNING: BEFORE PLACING YOUR CHILD ON THE CHANGE TABLE, ALWAYS CHECK ITS ATTACHMENT AND STABILITY.

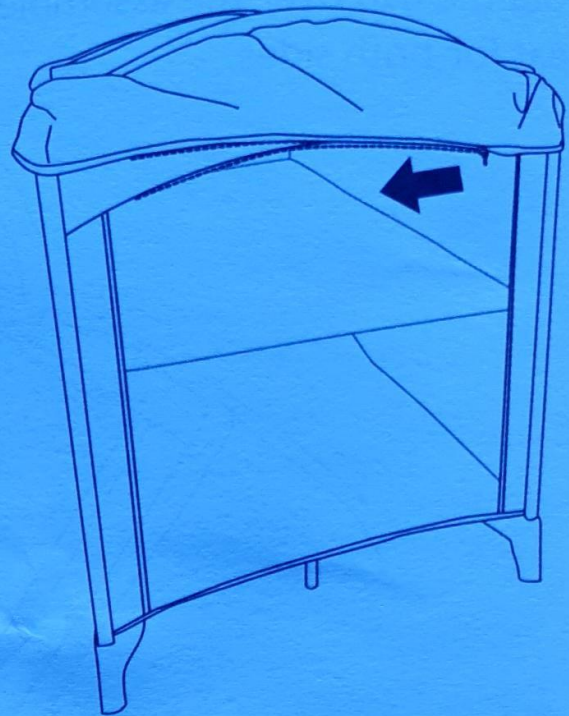

6. Always use the harness when the change table is in use.

⚠ WARNING: NEVER LEAVE YOUR CHILD UNATTENDED. TO PREVENT FALLS THE CHANGE TABLE SHOULD NOT BE USED ONCE A CHILD CAN SIT UP. NEVER PLACE A CHILD IN THE COT WHEN THE CHANGE TABLE IS IN PLACE.

ALWAYS USE THE HARNESS WHEN USING THE CHANGE TABLE.

Attaching:

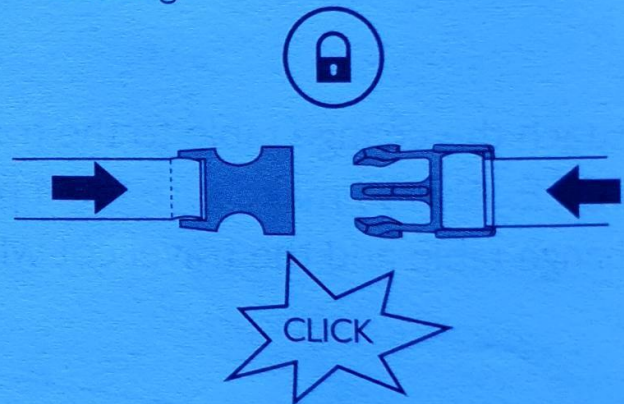

Removing:

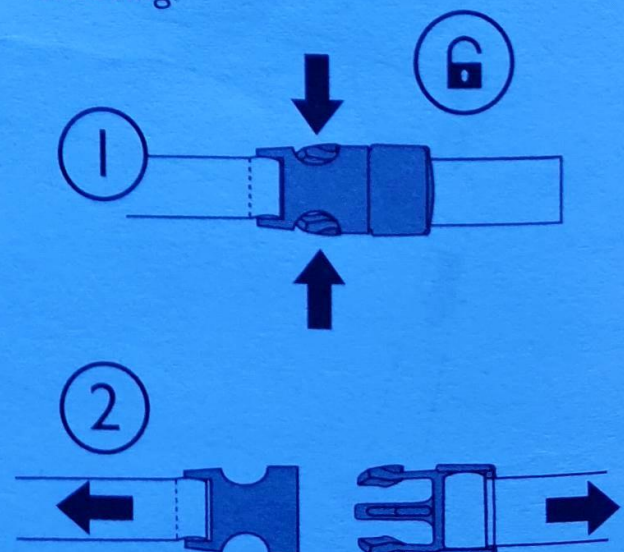

Care and Maintenance:

- Regularly inspect and maintain your product to ensure the freedom of movements of the locking devices and assembly fittings are tightened correctly.
- To prolong the life of your cot, keep it clean and do not leave it in the direct sunlight for extended periods of time .
- Removable fabric covers and trims may be cleaned using warm water with mild detergent. Allow it to dry fully, preferably away from the direct sunlight.
- Non removable fabric covers and trims may be spot cleaned using a damp sponge with soap or a mild detergent. Allow it to dry completely before folding or storing it away.
- In some climates the fabrics and trims may be affected by mould and mildew. To help prevent this occurring, do not fold or store the product if damp or wet. Always store the product in a well ventilated area.
- Do not dry clean.
- Do not use bleach.
- Do not iron.
- To maintain the safety of your cot discontinue use if there are bent, torn, worn or broken parts.

 **WARNING:** IF THE SIDES DO NOT LATCH FIRMLY OR THERE ARE HOLES IN THE MESH SIDES, DISCONTINUE USE IMMEDIATELY.

zummi

**Due to variation in style and design the illustrations used in this instruction manual are generic.
Variation in design may occur in the images shown.**

Supplied by Euroactive HK. Ltd.

A3/ 3Fl, West Wing TST Centre, 66 Mody Road, TST East, Kowloon, Hong Kong

Imported by Farmers' Trading Company Limited

Private Bag 94060, South Auckland Mail Centre, 21 Laidlaw Way, Flat Bush,
Manukau City, Auckland, New Zealand